

# enea

New Inspiration 2023 by Enea.



**enea**

**2022 National Design Award  
Premio Nacional de Diseño 2022**



# Lore

P. 08 - 27



# Mate

P. 28 - 45



# Taber

P. 46 - 53

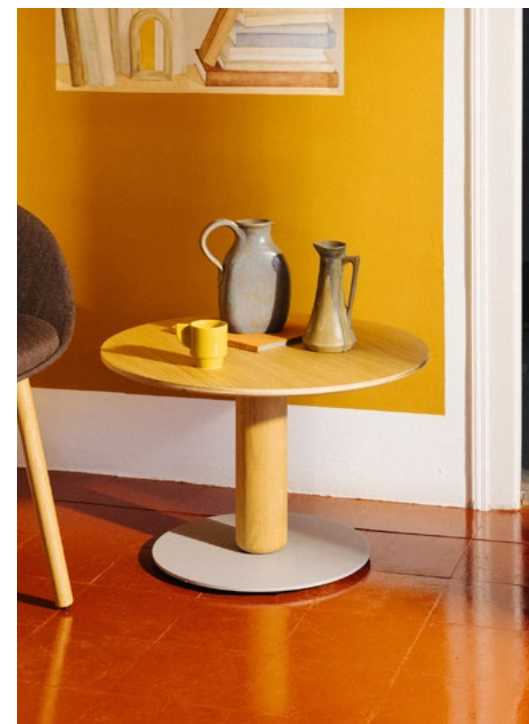

# Tema

P. 54 - 59



# Inspired by life, made by enea

At Enea, we find inspiration in everyday life when we design and create our furniture. Our beautiful, strong, and sustainable pieces travel to all corners of the globe from our factory in the Basque Country, to keep you company while you are eating, chatting, or working. While you are waiting, sharing, or relaxing. At Enea we like to inspire and help turn ideas into a reality. We don't just settle for a standard product, but constantly strive to offer customised solutions to help create unique spaces. We are pleased to say that our family continues to grow, so let us introduce our latest designs. Now it is your turn to let your imagination run wild...

En Enea, diseñamos y fabricamos mobiliario inspirándonos en cómo vivimos hoy en día. Desde nuestra fábrica del País Vasco viajan a todo el mundo muebles fuertes, estéticos y sostenibles que nos acompañan a la hora de comer, conversar y trabajar. A la hora de esperar, compartir y descansar. En Enea nos gusta inspirar y ayudar a que las ideas se hagan realidad. No nos conformamos con un producto estándar y nos esforzamos para poder ofrecer soluciones personalizadas que te ayuden a crear espacios todavía más singulares. Nuestra familia de diseños crece y queremos presentártela. Ahora te toca a ti, si quieres con nuestra colaboración, echar a volar tu imaginación.



# Lore

By Estudi Manel Molina

Comfort and elegance in equal measure. Customise Lore to your taste and let it accompany you while you are working or sharing a meal, amongst many other things.

Comodidad y elegancia a partes iguales. Personalízala a tu gusto y haz que Lore te acompañe a la hora de trabajar, compartir una comida y mucho pero que mucho más.



Lore 4L in Kvadrat Divina Melange 3 457, with legs in RAL 9005 Black.



# Stay



“A brand new day is about to start. Everything is ready to escape the hustle and bustle, to weather the storm, and to weave new paths”.

“Un nuevo día está a punto de comenzar. Todo preparado para esquivar ajetreos, sortear tempestades y zigzaguear nuevos caminos”.



Lore Wood in Kvadrat Clara 2 388.

**“It is so incredibly easy to have a lie in when you’re at your weekend retreat in the mountains... when you can finally chill after all the craziness of the week”.**

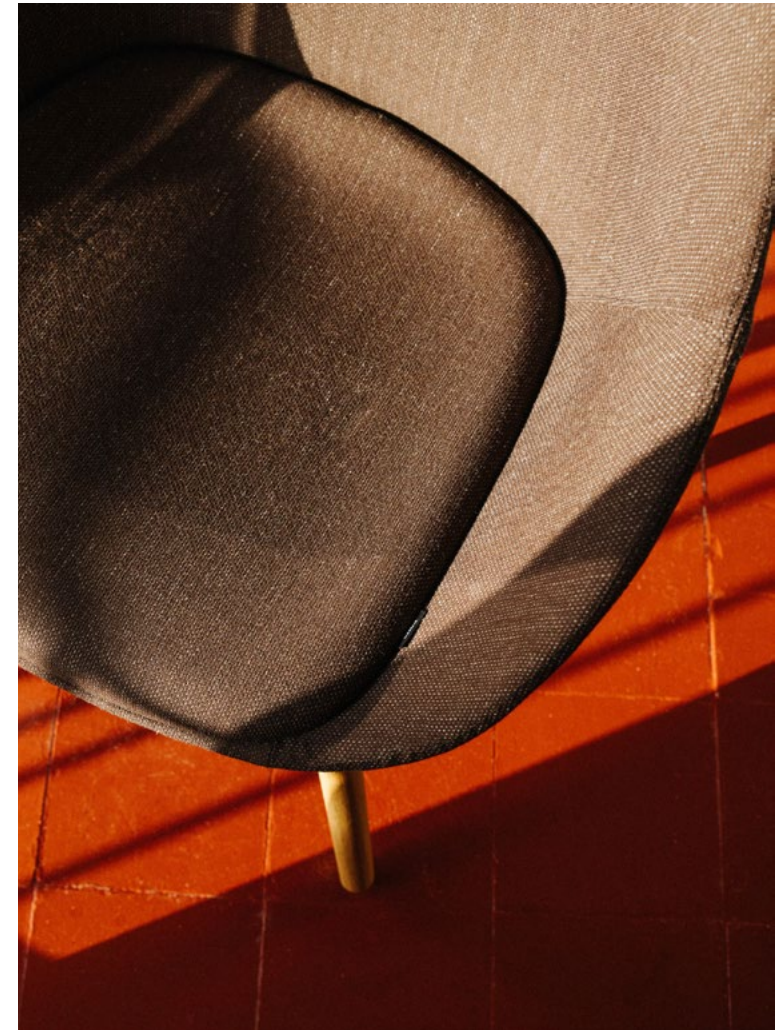

**“Esa facilidad con la que se les pegan las sábanas cuando van a la casa de la montaña, esa ausencia de prisa que tanta falta les hacía”.**





### #InspiredByLife

Means providing our customers with the widest possible range of colours and finishes so they can give free rein to their imagination.

Es poner al alcance de nuestros clientes la gama de acabados y colores más amplia posible para que den rienda suelta a su imaginación.



Lore Confident with castors and Lore Sledge in Kvadrat Divina Melange 3 527, on RAL 7032 Sand frames. Lore 4L in RAL 7032 Sand. Lore Wood and Lore Spin with seat pads in Kvadrat Divina Melange 3 237 (Lore Spin with legs in RAL 7032 Sand). Lore Confident and Lore Office in Kvadrat Divina Melange 3 237, on RAL 7032 Sand frames. Lore Spin Wood in Kvadrat Divina Melange 3 237.



# Work

“Little by little, the distance between the office and home became shorter and shorter, until home became the office”.



“Centímetro a centímetro, fue acortando la distancia entre trabajar en la oficina y trabajar en casa hasta que su casa se convirtió en su oficina”.



Lore Spin in RAL 7032 Sand, with seat pad in Kvadrat Clara 2 427.

### #MadeByEnea

Means cooperating with architects and interior designers from all around the world to help create unique projects.

Va de cooperar con arquitectos e interioristas de todo el mundo para ayudarles a crear proyectos singulares.

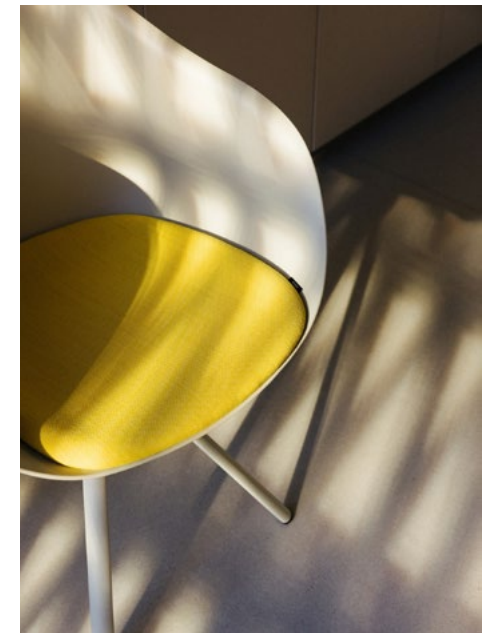



**Eat**



**“What started off as just a quick snack became a relaxed and pleasant lunch. Bon appetit!”**

**“Lo que iba a ser un rapidísimo tentempié se ha convertido en un sosegado y placentero almuerzo. On egin”.**

Love Spin Wood in Pantone 174C Teja, with seat pad in Kvadrat Tomus 4 554.



Lore Spin in Kvadrat Clara 2 388, with legs in RAL 9005 Black.



### #InspiredByLife

Means helping thousands of people across the globe to enjoy authentic environments that are both functional and aesthetically pleasing.

Es facilitar que miles de personas de todo el mundo puedan disfrutar de entornos funcionales, estéticos y auténticos.



**“An irresistible aroma escapes from the kitchen.  
The sizzling of the pot seems to confirm it.  
Something great is on its way: animated after-dinner  
conversation guaranteed!”.**



**“Un aroma irresistible se escapa de la cocina.  
El crepitar del puchero parece confirmarlo. Algo bueno  
está por llegar: larga será la sobremesa”.**



Lore 4L in Pantone 5435C Sky, with seat pad in Kvadrat Divina Melange 3 731.

## Lore

The Lore chair stands out for its equal measure of comfort and elegance. Its gentle lines allude to its name (lore means “flower” in Basque). This collection consists of 8 different frames and allows for several configurations. The shell is available in different finishes: polypropylene with either a polypropylene or upholstered seat pad, and a fully upholstered option.

La silla Lore se caracteriza por su comodidad y elegancia a partes iguales, y su amable forma hace alusión a su nombre (lore significa flor en euskera). La colección consta de 8 estructuras, permitiendo diferentes configuraciones, y la carcasa puede tener distintos acabados: en polipropileno con pad de asiento de polipropileno o tapizado, y totalmente tapizada.

## Products / Productos

Lore 4L

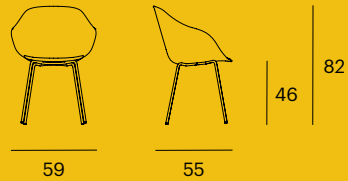

Lore Sledge / Lore Patin

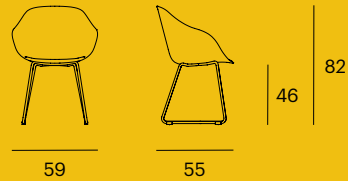

Lore Wood

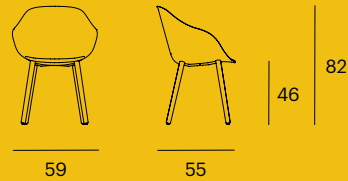

Lore Spin

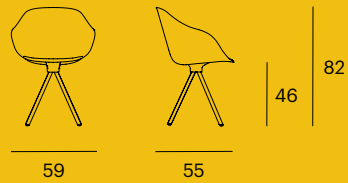

Lore Spin Wood

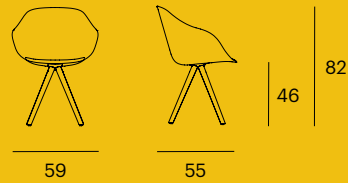

Lore Confident

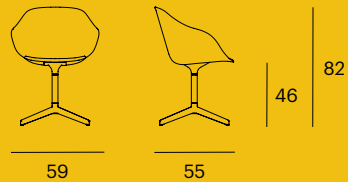

Lore Confident with castors / Lore Confident con ruedas

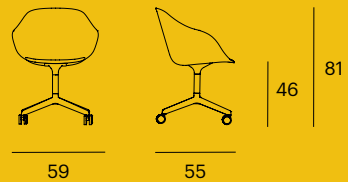

Lore Office / Lore Oficina

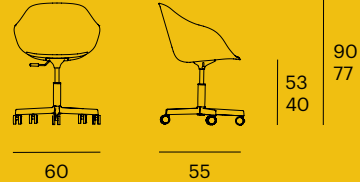

## Shell / Carcasa



Recyclable polypropylene shell + seat pad.  
Carcasa + pad de asiento de polipropileno reciclable.



Recyclable polypropylene shell + seat pad upholstered in recyclable foam.  
Carcasa de polipropileno reciclable + pad de asiento tapizado en espuma reciclable.



Fully upholstered in recyclable foam.  
Tapizado completo en espuma reciclable.

## Finishes / Acabados



Scan the QR code to see the list of available finishes.  
Escanea el código QR para ver la lista de acabados.

Or click on this link:  
O clica en este enlace:

<https://enea.design/lore-finishes>

## Frame / Estructura

- Ø16 x 2 mm round cold rolled steel tube frame, either chromed or lacquered in Enea's colours (4L and Sledge versions).
- Solid oak wood adhesively joined to welded steel spider or to aluminium seat base (Wood and Spin Wood versions).
- Naturally varnished wood with polyurethane-based varnishes, in a matt finish, with UV resistant and anti-yellowing treatments (Wood and Spin Wood versions).
- Ø32 x 18 x 2 mm cold rolled steel elliptical tube frame, either chromed or lacquered in Enea's colours (Spin version).
- 4 or 5-star injected aluminium base, either polished or lacquered in Enea's colours (Confident and Office versions).
- Recyclable polypropylene (PP) pads and glide pads to protect base, legs, and floor.
- Frame connected to shell with steel screws.

- Estructura de tubo redondo de Ø16x2 mm de acero laminado en frío, cromado o lacado según colores Enea (versiones 4L y patín).
- Madera de roble macizo con unión a araña soldada de acero o a capitel de aluminio mediante encolado (versiones wood y spin wood).
- Barnizado natural de la madera con barnices en base a poliuretanos, acabado mate y con tratamiento resistente al ultravioleta y anti-amarilleo (versiones wood y spin wood).
- Estructura de tubo elíptico de Ø32x18x2 mm de acero laminado en frío, cromado o lacado según colores Enea (versión spin).
- Base de 4 o 5 radios de aluminio inyectado, pulido o lacado según colores Enea (versiones confident y oficina).
- Tacos y tacos patín de polipropileno (PP) reciclable para proteger las patas o la base así como el suelo.
- Unión de la estructura a la carcasa con tornillos de acero.

## Accessories / Accesorios

- Felt feet.
- Chromed castors (for Confident and Office versions only).

- Pies de fieltro.
- Ruedas cromadas (únicamente para versiones confident y oficina).

## Certificates / Certificados

- Demonstrated results according to standard UNE-EN 16139:2013.

- Resultados satisfactorios según norma UNE-EN 16139:2013.

## Eco features / Características Eco

- Eco-designed (ISO 14006).
- Environment management system that meets ISO 14001.
- Solid oak wood from European forests.
- Indoor Advantage Gold certified (indoor air quality).
- Polyurethane foam free from latex and hazardous substances.
- Selection of upholstery fabrics made of wool, recycled (and recyclable) fibres, and leather.
- Highly recyclable PP with low additive content, according to EU recommendations for the improvement of plastic recyclability.
- The number of components has been reduced, and their ease of separation has been enhanced, to make the end-of-life phase more manageable. All these components are 100% recyclable or reusable.
- All the cardboard used for packaging is recyclable.

- Ecodiseñada (ISO 14006).
- Entorno que cumple con ISO 14001.
- Madera de roble macizo proveniente de bosques europeos.
- Certificada con Indoor Advantage Gold (calidad del aire en espacios interiores).
- Espumas de poliuretano (foam) sin contenido en látex y sustancias peligrosas.
- Selección de tejidos para tapicería de lana, fibras recicladas (y reciclables) y piel.
- PP altamente reciclable con bajo contenido en aditivos, según recomendaciones de la UE para mejorar la reciclabilidad de plásticos.
- Para la fase de fin de vida se han minimizado el número de componentes y su facilidad de separación, todos ellos reciclables al 100 % o reutilizables.
- Todos los cartones usados en su embalaje son reciclables.

## Weight-volume / Peso-volumen

Product	Weight	Dimensions	Units/Box	Weight/Box	Heat load
Lore 4L chair	5.8 kg	66.5 x 57.5 x 96 cm	1	7.3 kg	163.69 MJ
Lore Sledge chair	6.4 kg	66.5 x 57.5 x 96 cm	1	7.9 kg	173.51 MJ
Lore Wood chair	5.9 kg	66.5 x 57.5 x 96 cm	1	7.4 kg	182.89 MJ
Lore Spin chair	6.7 kg	66.5 x 57.5 x 96 cm	1	8.2 kg	173.56 MJ
Lore Spin Wood chair	5.5 kg	66.5 x 57.5 x 96 cm	1	7 kg	187.22 MJ
Lore Confident chair	7.1 kg	66.5 x 57.5 x 96 cm	1	8.6 kg	169.70 MJ
Lore Confident chair with castors	7.4 kg	66.5 x 57.5 x 96 cm	1	8.9 kg	192.53 MJ
Lore Office chair*	7.3 kg	61 x 66.5 x 45 cm	1	8.8 kg	201.24 MJ

\*Shipped disassembled and with instructions. / \*Se envía desmontada y con instrucciones.

# Mate

By Estudi Manel Molina

The new Mate collection has been designed to create multiple configurations. This chair can easily adapt to as many settings as you can possibly imagine. In short, this is a great ally for your daily life.

La nueva colección Mate está diseñada para poder crear múltiples configuraciones. Se trata de una silla que te puede acompañar en tantos contextos como imaginación tengas. Una gran aliada para tu día a día.







# Share

“The tasting has taken them to places that they couldn’t have possibly imagined... A real journey of aromas, flavours, and colours”.



Mate Spin Wood in Kvadrat Re-wood 1358.

“La cata les ha llevado por derroteros que no imaginaban, todo un viaje de aromas, sabores y colores”.



**#InspiredByLife**

Means functionality. In other words, it is the ability to quickly transform an area designed to share ideas into a tidy space.

Va de funcionalidad; es decir, que lo que ha sido un espacio para compartir ideas se pueda convertir, en unos instantes, en un espacio bien recogido.



Mate C in Pantone 5753C Olive, with legs in RAL 9005 Black.





Mate Confident with castors and Mate C in Kvadrat Canvas 2 964, on RAL 9005 Black frames. Mate Spin Wood in Kvadrat Tonus 4 131. Mate Confident and Mate Office in Kvadrat Tonus 4 131, on RAL 9005 Black frames. Mate Spin in Pantone 5753C Olive, with seat pad in Kvadrat Canvas 2 964, and legs in RAL 9005 Black. Mate Wood in Pantone 5753C Olive, with seat pad in Kvadrat Tonus 4 131.



### #MadeByEnea

Means designing and making strong and durable furniture that contributes to a more sustainable use of the planet's resources.

Va de diseñar y fabricar muebles fuertes y duraderos que contribuyan a hacer un uso más sostenible de los recursos del planeta.





# Eat

“The whole family has risen in unison. Sometimes, the best thing about a chair is to leave it empty and go out there to celebrate life”.



“La familia se ha levantado al unísono. A veces, lo mejor de una silla es dejarla vacía y salir ahí fuera a celebrar la vida”.

**“A chance encounter; a last-minute plan; a get-together that could be the beginning of something infinite”.**



**“Un encuentro casual, un plan de última hora, que tal vez sea el inicio de algo infinito”.**



Mate Spin in Kvadrat Clara 2 248, with legs in RAL 9016 White.



# Work



“The meeting is over, but the ideas keep on echoing in their heads. They’ll soon come alive, black on white, in half-filled notebooks”.

“La reunión ha terminado pero las ideas siguen reverberando en sus cabezas. Pronto cobrarán vida, negro sobre blanco, en libretas a medio llenar”.

**“Get ready in a few minutes because the night can be very long. That’s the attitude for today”.**



**“Prepararse en unos pocos minutos porque la noche puede ser muy larga. Esa es la actitud para hoy”.**



Mate C in Kvadrat Tonus 4 454, with legs in RAL 9005 Black.

## Mate

The Mate chair represents the epitome of versatility. This collection has been designed to create multiple configurations. It includes 7 different frames and is available with 3 types of shell, which include a full polypropylene shell, with the choice of an upholstered seat pad, and a fully upholstered option.

La silla Mate se compone de un asiento monocarcasa de polipropileno y es todo un ejemplo de versatilidad. La colección está diseñada para poder crear múltiples configuraciones, consta de 7 estructuras y la carcasa puede tener distintos acabados: en polipropileno, con pad de asiento tapizado, y totalmente tapizada.

## Products / Productos

Mate C

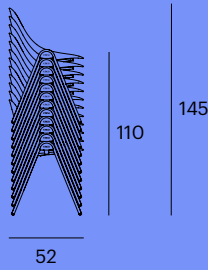
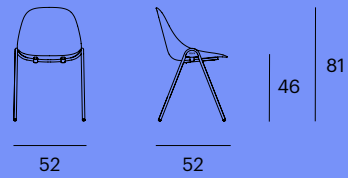

Mate Wood

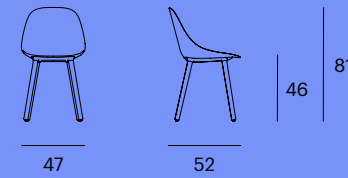

Mate Spin

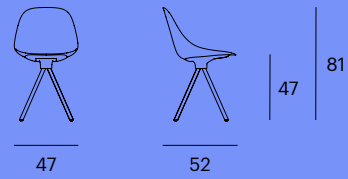

Mate Spin Wood

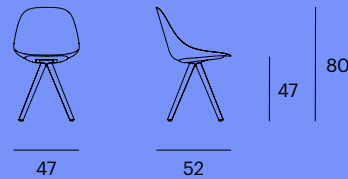

Mate Confident

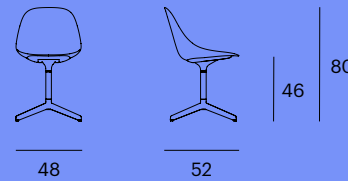

Mate Confident with castors /  
Mate Confident con ruedas

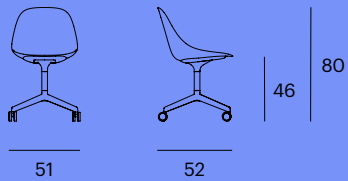

Mate Office / Mate Oficina

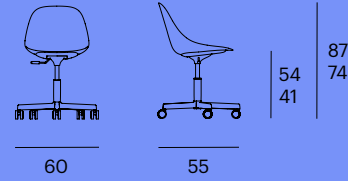

## Shell / Carcasa



Recyclable polypropylene shell.  
Carcasa de polipropileno reciclable.



Recyclable polypropylene shell + seat pad upholstered in recyclable foam.  
Carcasa de polipropileno reciclable + pad de asiento tapizado en espuma reciclable.



Fully upholstered in recyclable foam.  
Tapizado completo en espuma reciclable.

## Finishes / Acabados



Scan the QR code to see the list of available finishes.  
Escanea el código QR para ver la lista de acabados.

Or click on this link:  
O clica en este enlace:

<https://enea.design/mate-finishes>

## Frame / Estructura

- Ø18 x 2 mm cold rolled steel round tube frame, either chromed or lacquered in Enea's colours, with recyclable polypropylene (PP) support mechanism to prevent damage during stacking (C version).
- Solid oak wood adhesively bonded to aluminium seat base (Wood and Spin Wood versions).
- Naturally varnished wood with polyurethane-based varnishes, in a matt finish, with UV resistant and anti-yellowing treatments (Wood and Spin Wood versions).
- Ø32 x 18 x 2 mm cold rolled steel elliptical tube frame, either chromed or lacquered in Enea's colours (Spin version).
- 4 or 5-star injected aluminium base, either polished or lacquered in Enea's colours (Confident and Office versions).
- Rubber or recyclable PP pads to protect both legs and floor.
- Frame connected to shell with steel screws.

- Estructura de tubo redondo de Ø18x2 mm de acero laminado en frío, cromado o lacado según colores Enea, con un mecanismo de apoyo en polipropileno (PP) reciclable para no dañarla durante el apilado (versión C).
- Madera de roble macizo con unión a capitel de aluminio mediante encolado (versiones wood y spin wood).
- Barnizado natural de la madera con barnices en base a poliuretanos, acabado mate y con tratamiento resistente al ultravioleta y anti-amarilleo (versiones wood y spin wood).
- Estructura de tubo elíptico de Ø32x18x2 mm de acero laminado en frío, cromado o lacado según colores Enea (versión spin).
- Base de 4 o 5 radios de aluminio inyectado, pulido o lacado según colores Enea (versiones confident y oficina).
- Tacos de caucho o de PP reciclable para proteger las patas así como el suelo.
- Unión de la estructura a la carcasa con tornillos de acero.

## Accessories / Accesorios

- Felt feet.
- Connector (for Mate C only).
- Writing table (for Mate C only).
- Chromed castors (for Confident and Office versions only).

- Pies de fieltro.
- Conector (únicamente para Mate C).
- Tablilla de escritura (únicamente para Mate C).
- Ruedas cromadas (únicamente para versiones confident y oficina).

## Certificates / Certificados

- Demonstrated results according to standard UNE-EN 16139:2013.

- Resultados satisfactorios según norma UNE-EN 16139:2013.

## Eco features / Características Eco

- Eco-designed (ISO 14006).
- Environment management system that meets ISO 14001.
- Solid oak wood from European forests.
- Indoor Advantage Gold certified (indoor air quality).
- Polyurethane foam free from latex and hazardous substances.
- Selection of upholstery fabrics made of wool, recycled (and recyclable) fibres, and leather.
- Highly recyclable PP with low additive content, according to EU recommendations for the improvement of plastic recyclability.
- The number of components has been reduced, and their ease of separation has been enhanced, to make the end-of-life phase more manageable. All these components are 100% recyclable or reusable.
- All the cardboard used for packaging is recyclable.

- Ecodiseñada (ISO 14006).
- Entorno que cumple con ISO 14001.
- Madera de roble macizo proveniente de bosques europeos.
- Certificada con Indoor Advantage Gold (calidad del aire en espacios interiores).
- Espumas de poliuretano (foam) sin contenido en látex y sustancias peligrosas.
- Selección de tejidos para tapicería de lana, fibras recicladas (y reciclables) y piel.
- PP altamente reciclable con bajo contenido en aditivos, según recomendaciones de la UE para mejorar la reciclabilidad de plásticos.
- Para la fase de fin de vida se han minimizado el número de componentes y su facilidad de separación, todos ellos reciclables al 100 % o reutilizables.
- Todos los cartones usados en su embalaje son reciclables.

## Weight-volume / Peso-volumen

Product	Weight	Dimensions	Units/Box	Weight/Box	Stackable units	Heat load
Mate C chair	4.7 kg	66.5 x 57.5 x 96 cm	3	6.2 kg	12	106.28 MJ
Mate Wood chair	4.5 kg	66 x 50 x 100 cm	1	6 kg	-	124.18 MJ
Mate Spin chair	6.2 kg	66 x 50 x 100 cm	1	7.7 kg	-	115.13 MJ
Mate Spin Wood chair	5.2 kg	66 x 50 x 100 cm	1	6.7 kg	-	130.48 MJ
Mate Confident chair	6.8 kg	66 x 50 x 100 cm	1	8.3 kg	-	106.32 MJ
Mate Confident chair with castors	7.1 kg	66 x 50 x 100 cm	1	8.6 kg	-	129.25 MJ
Mate Office chair*	6.9 kg	61 x 66.5 x 45 cm	1	8.4 kg	-	136.76 MJ

\*Shipped disassembled and with instructions. / \*Se envía desmontada y con instrucciones.



# Taber

By Estudi Manel Molina

The Taber table is a versatile and elegant piece that is ideal for coffee shops, work environments, and any setting that needs to be adapted to today's life. It features a unique wooden structure which is available in two different heights.

La mesa Taber es una mesa elegante y versátil, dispuesta a ser parte de cafeterías, entornos de trabajo y, en general, de lugares que se quieren adaptar a la vida de hoy. Dispone de dos alturas y una estructura de madera que la hace única.



37 cm high Taber, with oak round table top, and round base in RAL 7004 Grey.



**#InspiredByLife**

Means being committed to creating design furniture for the life of today and tomorrow. Because there is no better fashion than timelessness.

Es estar comprometidos con crear mobiliario de diseño para la vida de hoy y de mañana. Porque no hay mejor moda que la atemporalidad.



73 cm high Taber, with oak round table top, and round base in RAL 9005 Black.

**“Perhaps other areas of the house were more spacious,  
but this was their favourite corner to open a book and  
let it last a heartbeat”.**



**“Tenía otras zonas de la casa tal vez más espaciosas,  
pero este era su rincón favorito para abrir un libro  
y que le durase un suspiro”.**



37 cm high Taber, with oak round table top, and round base in RAL 7004 Grey.

## Taber

The Taber table features a unique wooden structure, made of either oak or beech, which is available in two different heights (37 and 73 cm). Its tabletop can be made of HPL, Fenix, or oak wood; and both the tabletop and lacquered steel base are available in different shapes (circular, square, or rounded-square).

La mesa Taber dispone de dos alturas (37 y 73 cm) y una estructura de madera de roble o haya que la hace única. La base de acero lacado y la encimera pueden tener distintas formas (circular, cuadrada o cuadróide), y el tablero puede ser de diferentes materiales: roble, Fenix y HPL.

## Products / Productos

### 37 cm high Taber table / Mesa Taber 37 cm

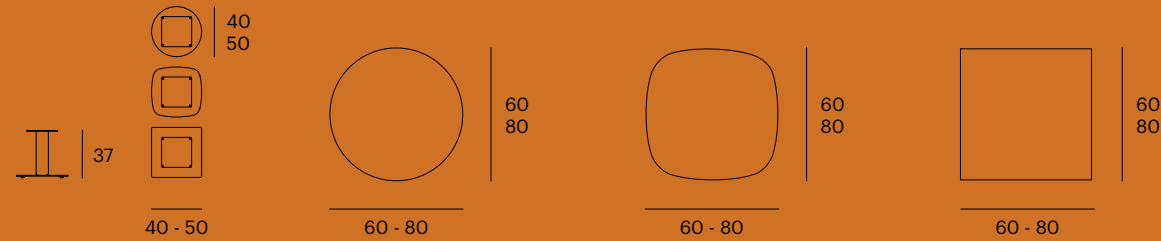

### 73 cm high Taber table / Mesa Taber 73 cm

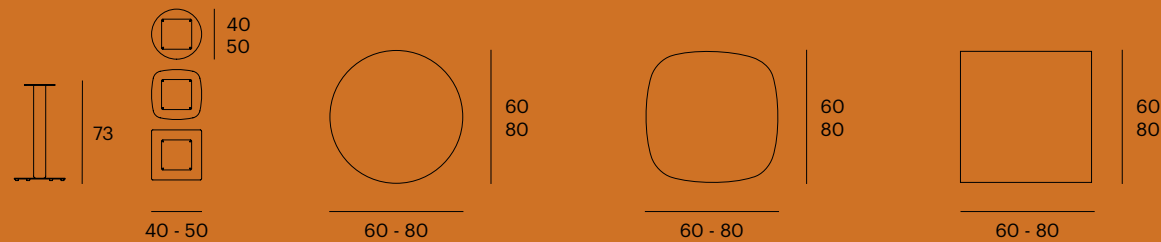

## Tabletop / Encimera



Laminated oak wood.  
Madera laminada de roble.



Fenix NTM.



HPL Compact.

## Finishes / Acabados



Scan the QR code to see the list of available finishes.  
Escanea el código QR para ver la lista de acabados.

Or click on this link: <https://enea.design/taber-finishes>  
O clicla en este enlace:

## Frame / Estructura

- Lacquered steel base in Enea's colours, connected to the tube by glued bolts for better grip and a more visually pleasing union, to create an effect as if the tube was floating over the base.
- Non-slip rubber caps to protect both base and floor, and to reduce noise when moved.
- Ø95 mm tube made of solid oak or beech wood from European forests.
- Naturally varnished wood with polyurethane-based varnishes, in a matt finish, with UV resistant and anti-yellowing treatments.
- Steel tabletop base, connected to the tube with glued bolts.
- Frame connected to tabletop with steel screws.

- Base de acero lacado según colores Enea, unida al tubo mediante bulones encolados para conseguir una mejor sujeción y una unión visualmente más estética, como si el tubo flotara sobre la base.
- Conteras de caucho antideslizantes para proteger la base de la mesa así como el suelo y reducir el ruido al desplazarla.
- Tubo de Ø95 mm de madera maciza en roble o haya proveniente de bosques europeos.
- Barnizado natural de la madera con barnices en base a poliuretanos, acabado mate y con tratamiento resistente al ultravioleta y anti-amarilleo.
- Soporte de la encimera de acero, unido al tubo mediante bulones encolados.
- Unión de la estructura a la encimera con tornillos de acero.

## Accessories / Accesorios

- Tabletop connector (for square tabletop only).

- Conector de encimeras (únicamente para encimera cuadrada).

## Certificates / Certificados

- Demonstrated results according to standards UNE-EN 581-3:2017 and UNE-EN 1730:2013.

- Resultados satisfactorios según normas UNE-EN 581-3:2017 y UNE-EN 1730:2013.

## Eco features / Características Eco

- Environment management system that meets ISO 14001.
- Oak or beech wood from European forests.
- The number of components has been reduced, and their ease of separation has been enhanced, in order to make the end-of-life phase more manageable. All these components are 100% recyclable or reusable.
- All the cardboard used for packaging is recyclable.

- Entorno que cumple con ISO 14001.
- Madera de roble o haya proveniente de bosques europeos.
- Para la fase de fin de vida se han minimizado el número de componentes y su facilidad de separación, todos ellos reciclables al 100 % o reutilizables.
- Todos los cartones usados en su embalaje son reciclables.

## Weight-volume / Peso-volumen

Product	Weight*	Dimensions	Units/Box	Weight/Box	Heat load
37 cm high frame	10 kg	49.5 x 54 x 103 cm	1	12 kg	51.33 MJ
73 cm high frame	14 kg	49.5 x 54 x 103 cm	1	16 kg	88.06 MJ
60 x 60 cm tabletop	9.1 kg	90 x 95 x 2 cm	1	9.7 kg	137.24 MJ
70 x 70 cm tabletop	12.6 kg	90 x 95 x 2 cm	1	13.2 kg	187.50 MJ
80 x 80 cm tabletop	16.6 kg	90 x 95 x 2 cm	1	17.2 kg	245.49 MJ

\*These may vary depending on the material, size and/or shape of the base and tabletop. / \*El dato puede variar dependiendo del material, tamaño y/o forma de la base o encimera.

# Tema

By Estudi Manel Molina

Tema is a highly stackable table designed for multipurpose and highly functional spaces which need to be transformed, in the blink of an eye, from one thing to another.

Tema es una mesa de gran apilabilidad pensada para espacios polivalentes y altamente funcionales que deben pasar, en un abrir y cerrar de ojos, de ser una cosa a ser otra.



Tema in Fenix NTM White, on RAL 9005 Black frame. Ema 4L in Camira Blazer CUZ1R, with legs in RAL 9005 Black.



### #MadeByEnea

Means spending many hours doing research, and collaborating with prestigious designers, to create furniture pieces that provide functionality and style to the spaces where we spend the most time.

Es invertir cientos de horas en investigación, y colaborar con diseñadores de prestigio, para crear muebles que doten de funcionalidad y estilo a los espacios en los que más tiempo pasamos.



Tema in Fenix NTM White, on RAL 9005 Black frame. Ema Sledge in Gabriel Medley 62054, with frame in Pantone 1245C Mustard.

## Tema

The Tema table features a steel tube frame, which can be either chromed or lacquered, and a tabletop and side panel which are available in Fenix or HPL. It features the same level of stackability that is often associated to chairs, enabling stacking of up to 10 units on the ground, and up to 20 units on the transport and storage trolley.

La mesa Tema está construida con una estructura de tubo de acero lacado o cromado, y una encimera y un faldón que pueden ser de Fenix y HPL. Representa en una mesa el concepto de apilabilidad (hasta 10 uds. sobre suelo y hasta 20 uds. sobre carro de transporte y almacenaje) habitual de las sillas.

## Products / Productos

Tema table / Mesa Tema

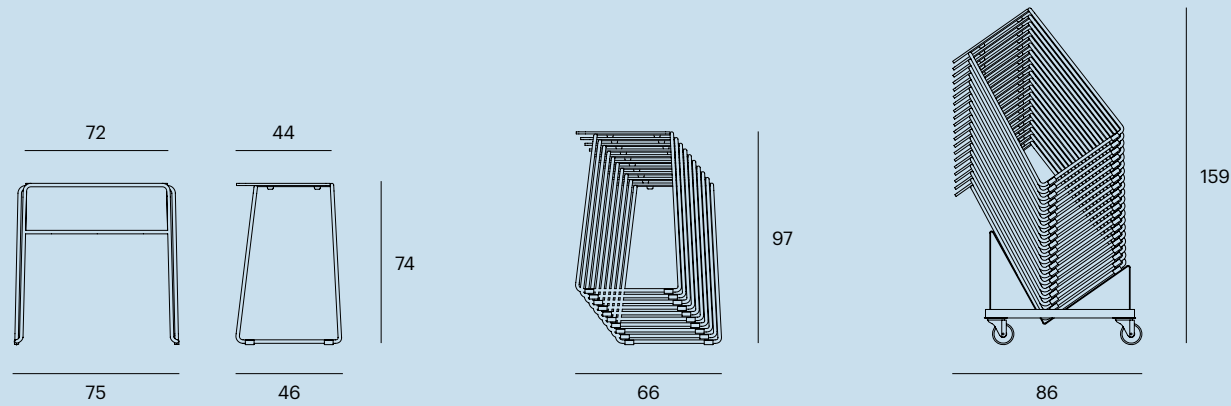

## Tabletop and side panel / Encimera y faldón

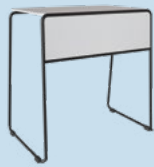

Fenix NTM.



HPL Compact.

## Finishes / Acabados



Scan the QR code to see the list of available finishes.  
Escanea el código QR para ver la lista de acabados.

Or click on this link: <https://enea.design/tema-finishes>  
O clicla en este enlace:

## Frame / Estructura

- Ø16 x 2 mm round cold rolled steel tube frame, either chromed or lacquered in Enea's colours. Thanks to the use of a lighter tube structure, as opposed to the more typical solid frame, it can be easily handled by a single person.
- Rubber non-slip pads to protect the tabletop during stacking.
- Recyclable polypropylene glide pads to protect both frame and floor during stacking.
- Frame connected to tabletop with steel screws.

- Estructura de tubo redondo de Ø16x2 mm de acero laminado en frío, cromado o lacado según colores Enea. Gracias a la utilización de una estructura de tubo más liviana que la varilla, se facilita su manipulación por una sola persona.
- Conteras de caucho antideslizantes para proteger la encimera de la mesa durante el apilado.
- Tacos patín en polipropileno reciclable para proteger la estructura de la mesa, también durante el apilado, así como el suelo.
- Unión de la estructura a la encimera con tornillos de acero.

## Accessories / Accesorios

- Felt feet.
- Transport and storage trolley.

- Pies de fieltro.
- Carro de transporte y almacenaje.

## Certificates / Certificados

- Demonstrated results according to standard UNE-EN 1730:2013.

- Resultados satisfactorios según norma UNE-EN 1730:2013.

## Eco features / Características Eco

- Environment management system that meets ISO 14001.
- The number of components has been reduced, and their ease of separation has been enhanced, in order to make the end-of-life phase more manageable. All these components are 100% recyclable or reusable.
- All the cardboard used for packaging is recyclable.

- Entorno que cumple con ISO 14001.
- Para la fase de fin de vida se han minimizado el número de componentes y su facilidad de separación, todos ellos reciclables al 100 % o reutilizables.
- Todos los cartones usados en su embalaje son reciclables.

## Weight-volume / Peso-volumen

Product	Weight	Dimensions	Units/Box	Weight/Box	Stackable units	Heat load
Tema table	2 kg	76 x 88 x 83.5 cm	2	4.6 kg	10-20	117.43 MJ





# Enea, winner of the 2022 National Design Award

## Enea, empresa ganadora del Premio Nacional de Diseño 2022



This is the highest recognition for the design industry in Spain.

It is awarded by the Ministry of Science and Innovation to acknowledge the work of professionals and companies that have greatly contributed to increasing the prestige of Spanish design.

Se trata del mayor reconocimiento del sector a nivel nacional. Lo entrega el Ministerio de Ciencia e Innovación del Gobierno de España para reconocer a los profesionales y empresas que han contribuido significativamente al incremento del prestigio del diseño español.

### Recognition for a way of doing things

Enea represents a unique milestone in Spanish design, as it was created -and continues to work- as a cooperative. This means that many of the staff are also owners of the company. Therefore, our cooperation with designers, consultants, distributors, and architects is part of our DNA, and is what helps us advance with a commitment to a set of shared values that have a strong impact on the well-being of the community.

### A proven approach

Enea was created in 1984 within the Eredu cooperative, which was initially focused on metal solutions as part of the Mondragon Corporation (Spain's second industrial group). Since then, the company has been committed to designing and manufacturing solid, contemporary, and sustainable furniture for all types of public and private spaces, ranging from homes to restaurants, offices, and educational establishments, among others. Currently, Enea exports 89% of its designs to 42 countries across the five continents.

### A personal view of the world of design

From our very beginnings, we wanted to give our own particular touch to the world of design. Not only to get you a little closer to the Basque Country, or to give the Basque Country more presence in the world through our chairs, tables, and stools; but also because we believe that uniqueness, a different viewpoint, and a distinctive character are all necessary values to achieve what we call iconicity.

### Collaborations with prestigious designers

Our commitment to create design pieces that fuse together innovation, sustainability, and functionality has translated into collaborations with highly prestigious and experienced designers, such as Lievore Altherr Molina, Josep Llusca, and Gabriel Teixido. They have helped Enea to position itself as one of the European leaders in design furniture for both home and collective facilities.

**All of this, along with other factors, has contributed to this important recognition for which we are extremely grateful. We are all part of this award.**

### El reconocimiento a una forma de hacer las cosas

Enea supone un hito singular en el diseño español, ya que se creó —y seguimos funcionando— como una cooperativa. Es decir, gran parte de los trabajadores somos propietarios de la empresa. Así que la cooperación forma parte de nuestro ADN. Es nuestra manera de trabajar con diseñadores, prescriptores, distribuidores, arquitectos... para avanzar desde el compromiso con unos valores compartidos que repercutan en el bienestar de la comunidad.

### Una trayectoria contrastada

Enea nació en 1984 en el seno de la cooperativa Eredu, dedicada inicialmente a soluciones de metal y que forma parte de la Corporación Mondragon, el segundo grupo industrial de España. Desde entonces, nos hemos dedicado a diseñar y fabricar muebles fuertes, contemporáneos y sostenibles pensados para todo tipo de espacios públicos y privados, de hogares a restaurantes, de oficinas a centros de enseñanza, entre otros. Actualmente, exportamos el 89 % de nuestros diseños a un total de 42 países de los cinco continentes.

### Una mirada propia al mundo del diseño

Desde nuestros inicios, hemos querido aportar una mirada propia al mundo del diseño. No solo para que puedas acercarte un poco a Euskadi a través de nuestras sillas, mesas, taburetes... o para que Euskadi pueda estar todavía más presente en el mundo, sino porque creemos que la singularidad, las miradas diferentes, el carácter propio, son un valor necesario para eso que llamamos iconicidad.

### Colaboración con diseñadores de prestigio

La apuesta por crear piezas de diseño que fusionen innovación, sostenibilidad y funcionalidad se ha traducido en colaboraciones con diseñadores de gran prestigio y experiencia como Lievore Altherr Molina, Josep Llusca y Gabriel Teixido, que han ayudado a Enea a posicionarse como uno de los líderes europeos en mobiliario de diseño para hogar e instalaciones colectivas.

**Todo esto, y mucho más, ha hecho que hayamos recibido este importante reconocimiento del que estamos muy agradecidos. Todos somos, sois, parte de este premio.**

At Enea, we avoid conformism and constantly search for new ways to improve. We believe in the importance of small details, in carrying out each part of the process with the highest quality, and always doing so with a criteria for sustainability. Always looking for quality and sustainability that are objective and certified.

En Enea, huimos del conformismo para estar en constante búsqueda de nuevas formas de hacerlo mejor. Creemos en la importancia de los pequeños detalles, en ejecutar cada parte del proceso con la máxima calidad, y de hacerlo siempre bajo criterios de sostenibilidad. Calidad y sostenibilidad que sean objetivas y que puedan ser certificadas.

---

## Environmental certificates / Certificados medioambientales



### SCS Indoor Advantage Gold

The Indoor Advantage Gold certification guarantees that our tables and chairs comply with the most rigorous VOC (volatile organic compound) emissions standards, thereby ensuring healthy indoor air quality.

El certificado Indoor Advantage Gold demuestra que nuestras mesas y sillas garantizan una calidad del aire interior saludable al cumplir con las estrictas normativas de emisión de compuestos orgánicos volátiles (COV).



### AENOR Ecodesign (ISO 14006)

The ISO 14006 certification guarantees that Enea has a management system for the identification, control, and minimisation of the environmental impact at every stage in the life cycle of our furniture.

El certificado ISO 14006 certifica que Enea cuenta con un sistema de gestión para identificar, controlar y mejorar los impactos ambientales que se pueden producir en cada una de las fases del ciclo de vida de nuestros muebles, con el fin de intentar reducirlos al mínimo.



### AENOR Environmental Management (ISO 14001)

The ISO 14001 certification ensures that we have an environmental management system for the optimisation of the handling of our resources and waste materials, and for the reduction of any negative environmental impact derived from the design and manufacturing of our furniture.

La certificación ISO 14001 garantiza que disponemos de un sistema de gestión ambiental con el que optimizar la gestión de recursos y residuos, y reducir los impactos ambientales negativos derivados del diseño y producción de mobiliario.

---

## Quality certificates / Certificados de calidad



### AENOR Quality Management System (ISO 9001)

The ISO 9001 certification guarantees that Enea has a quality management system that enables us to organise and improve the design and manufacturing of our furniture.

La norma ISO 9001 constata que Enea cuenta con un sistema de gestión de la calidad que nos ayuda a organizar y sistematizar los procesos para la gestión y la mejora del diseño y producción de nuestros muebles.

Ola Auzoa, 4  
20250 Legorreta  
Gipuzkoa, Spain  
+34 943 806 275  
[www.eneadesign.com](http://www.eneadesign.com)  
@eneaofficial

Brand Strategy: Breaking Molds  
Art Direction: Asier Belloso  
Creativity: Breaking Molds  
Copywriting: Breaking Molds  
Photography: Silvia Gil-Roldán  
CGI: Kimu Studio  
Set Dressing: Maio  
Printing: mccgraphics  
Edition: March 2023